



Silicon Carbide Schottky Diode S1S65006RC1

V_{RRM}	=	650 V
$I_F (T_C=135\text{ }^\circ\text{C})$	=	8.8 A
Q_C	=	30 nC

Features

- 650V Schottky Rectifier
- Zero Reverse Recovery Current
- High-Frequency Operation
- Temperature-Independent Switching Behavior
- Extremely Fast Switching

Package

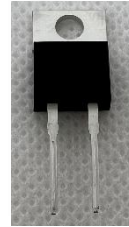

Benefits

- Replace Bipolar with Unipolar Rectifiers
- Essentially No Switching Losses
- Higher Efficiency
- Reduction of Heat Sink Requirements
- Parallel Devices Without Thermal Runaway



Part Number	Package
S1S65006RC1	TO220-2L

Applications

- Switch Mode Power Supplies (SMPS)
- Power Factor Correction
- Motor Drives

料号: 3960130000
 品名: SiC SBD塑封器件 650V 6A-T0220-2L(S1S65006RC1)
 版本: 01
 编辑: 温小花 2025.01.02
 审核: 王松 2025.01.02



Maximum Rated Values ($T_C=25^\circ\text{C}$ unless otherwise specified)

Symbol	Parameter	Value	Unit	Test Conditions	Note
V_{RRM}	Repetitive Peak Reverse Voltage	650	V		
V_R	DC Peak Reverse Voltage	650	V		
I_F	Continuous Forward Current	21	A	$T_C=25^\circ\text{C}$	Fig. 3
		8.8		$T_C=135^\circ\text{C}$	
		7.0		$T_C=150^\circ\text{C}$	
I_{FRM}	Repetitive Peak Forward Surge Current	26	A	$T_C=25^\circ\text{C}$, $t_p=10$ ms, Half Sine Pulse	
		22		$T_C=110^\circ\text{C}$, $t_p=10$ ms, Half Sine Pulse	
I_{FSM}	Non-Repetitive Forward Surge Current	34	A	$T_C=25^\circ\text{C}$, $t_p=10$ ms, Half Sine Pulse	
		27		$T_C=110^\circ\text{C}$, $t_p=10$ ms, Half Sine Pulse	
$I_{F,MAX}$	Non-Repetitive Forward Surge Current	424	A	$T_C=25^\circ\text{C}$, $t_p=10\mu\text{s}$, Square Wave Pulse	
		400		$T_C=110^\circ\text{C}$, $t_p=10\mu\text{s}$, Square Wave Pulse	
P_{tot}	Power Dissipation	65	W	$T_C=25^\circ\text{C}$	Fig. 4
		28		$T_C=110^\circ\text{C}$	
T_J	Operating Temperature	-55 to +175	$^\circ\text{C}$		
T_{stg}	Storage Temperature	-55 to +175	$^\circ\text{C}$		
	TO-247 Mounting Torque	1 8.8	Nm lbf-in	M3 Screw 6-32 Screw	

Electrical Characteristics ($T_J=25^\circ\text{C}$)

Symbol	Parameter	Value			Unit	Test Conditions	Note
		Min.	Typ.	Max.			
V_F	Forward Voltage		1.45		V	$I_F=6\text{A}$, $T_J=25^\circ\text{C}$	Fig. 1
			1.60			$I_F=6\text{A}$, $T_J=175^\circ\text{C}$	
I_R	Reverse Current		1		μA	$V_R=650\text{V}$, $T_J=25^\circ\text{C}$	Fig. 2
			8			$V_R=650\text{V}$, $T_J=175^\circ\text{C}$	
Q_C	Total Capacitive Charge		30		nC	$V_R=650\text{V}$, $T_J=25^\circ\text{C}$	Fig. 5
C	Total Capacitance		421		pF	$V_R=0\text{V}$, $T_J=25^\circ\text{C}$, $f=1\text{MHz}$	Fig. 6
			38			$V_R=400\text{V}$, $T_J=25^\circ\text{C}$, $f=1\text{MHz}$	
			37			$V_R=650\text{V}$, $T_J=25^\circ\text{C}$, $f=1\text{MHz}$	
E_C	Capacitance Stored Energy		5.6		μJ	$V_R=650\text{V}$	Fig. 7

Thermal Characteristics

Symbol	Parameter	Value	Unit	Note
$R_{\theta JC}$	Thermal Resistance(Junction to Case)	2.3	$^\circ\text{C/W}$	Fig. 8



Typical Performance

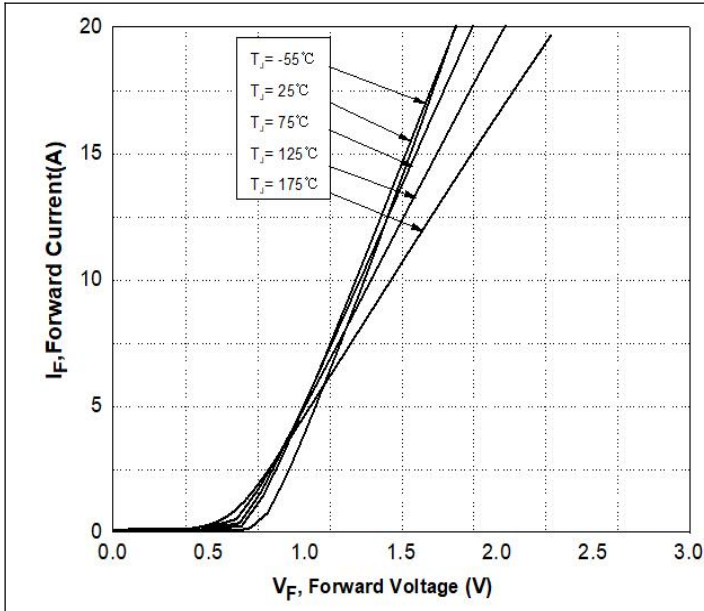

Figure 1. Forward Characteristics

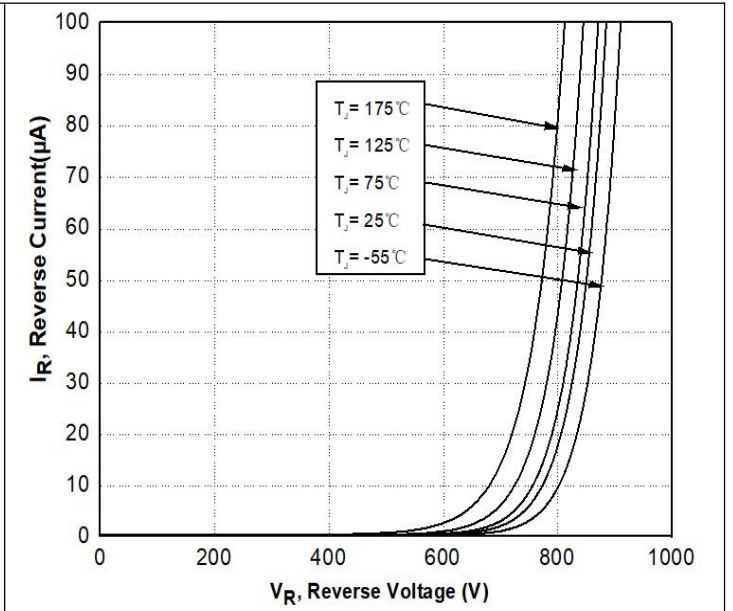

Figure 2. Reverse Characteristics

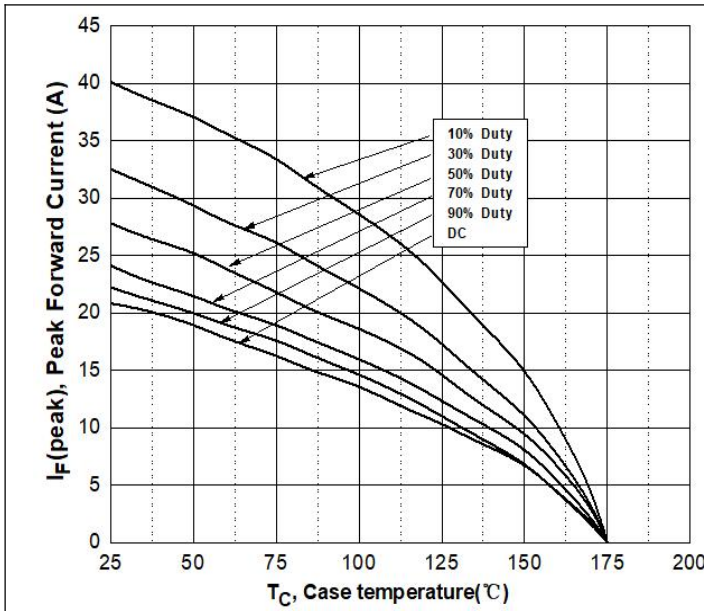

Figure 3. Current Derating

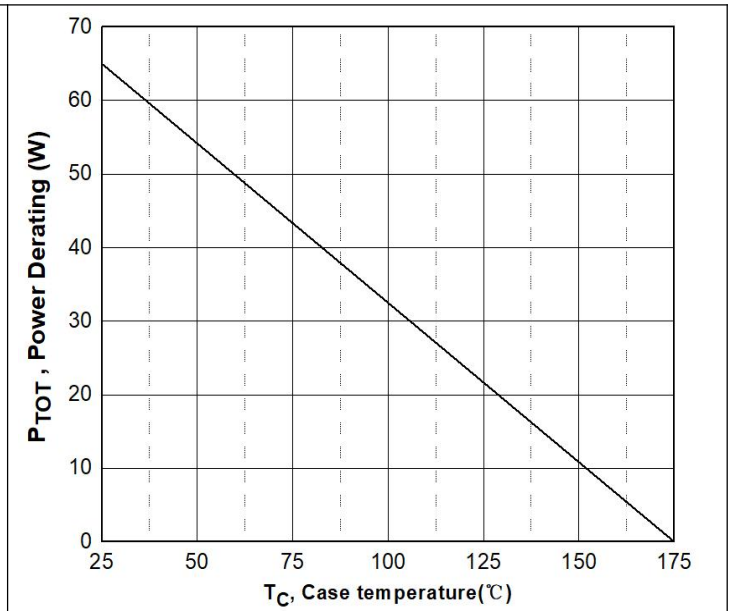

Figure 4. Power Derating



Typical Performance

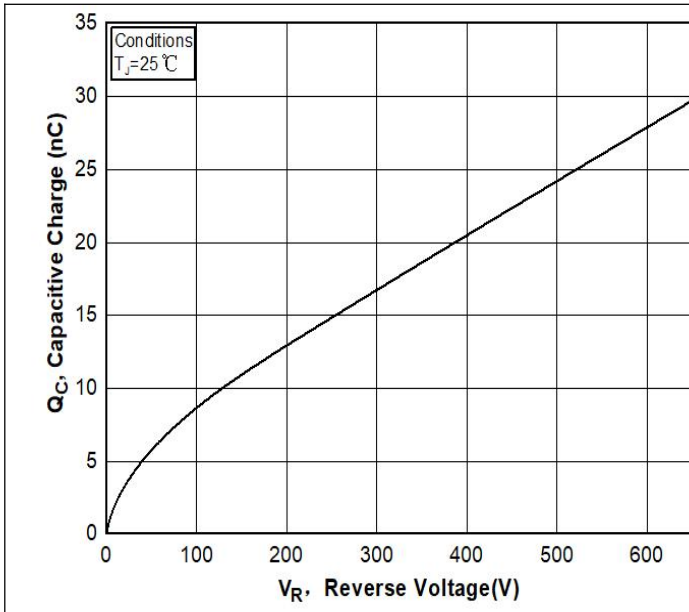

Figure 5. Capacitance Charge Vs. Reverse Voltage

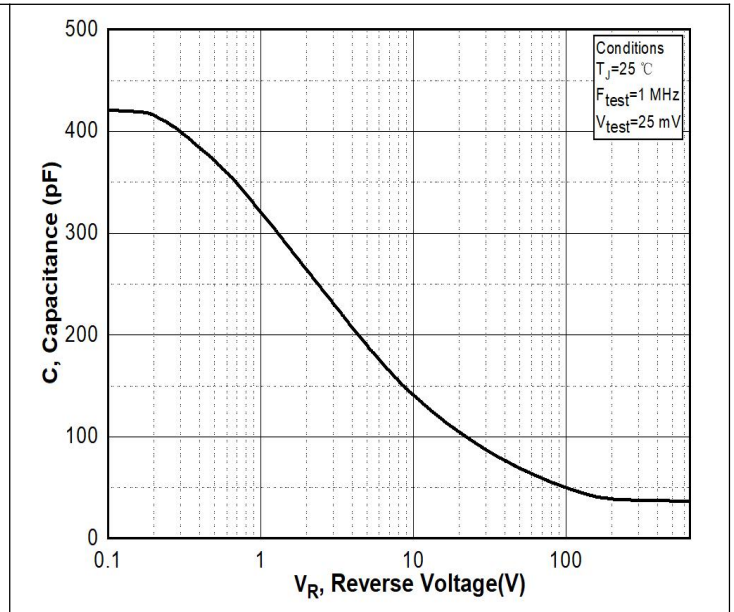

Figure 6. Capacitance Vs. Reverse Voltage

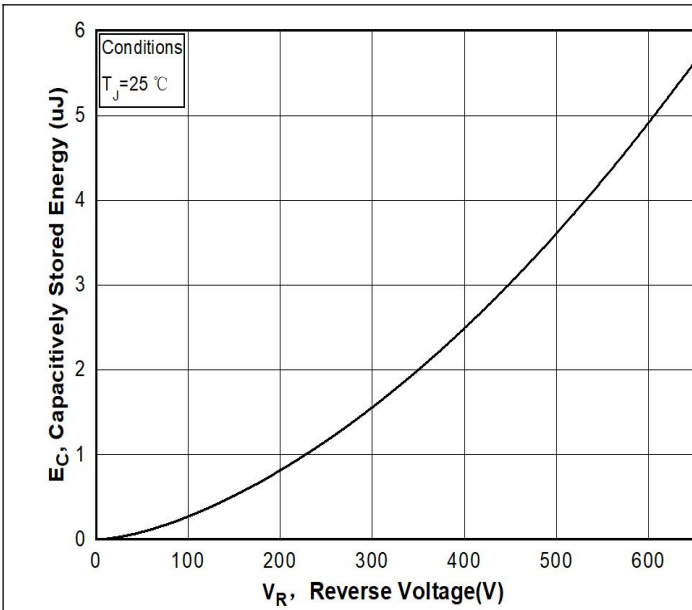

Figure 7. Capacitance Stored Energy

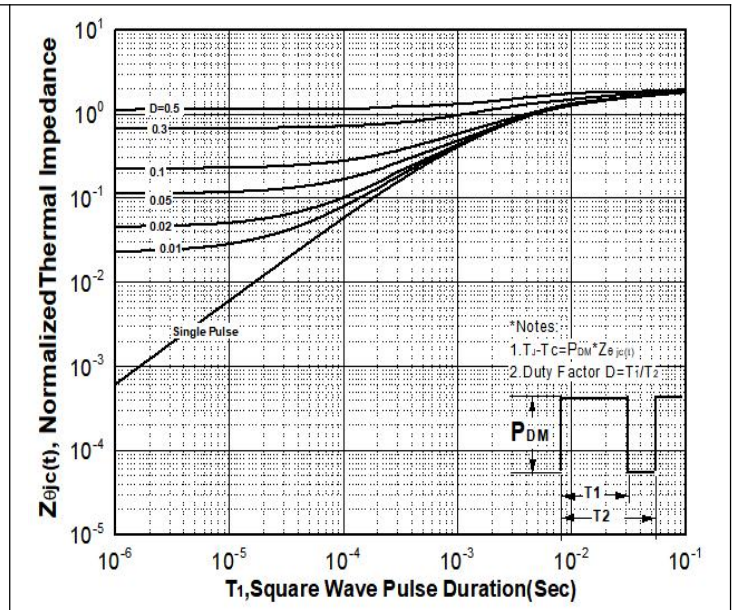
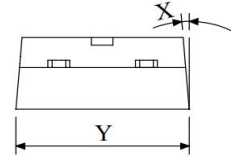
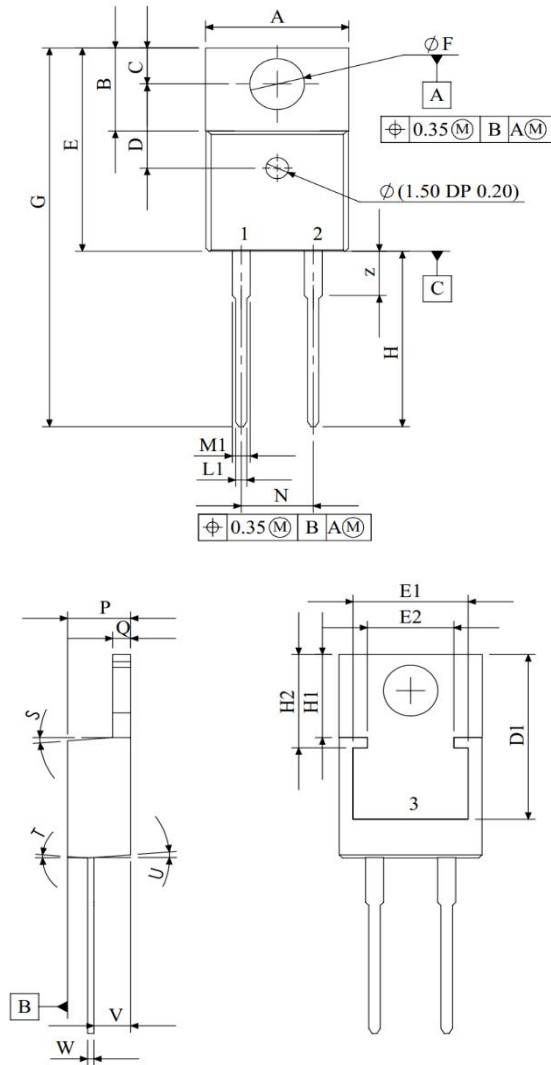

Figure 8. Transient Thermal Response Curve(Junction-to-Case)



Package Dimensions

Package TO-220-2L



SYMBOL	MIN (mm)	MAX (mm)
A	9.677	10.414
B	5.969	6.477
C	2.540	3.048
D	5.664	8.560
D1	12.450 REF	
E	14.986	15.621
E1	8.120 REF	
E2	6.100 REF	
F	3.632	3.886
G	28.067	29.134
H	12.700	13.970
H1	6.223 REF	
H2	7.040 REF	
L1	0.635	0.914
M1	1.143	1.397
N	4.953	5.207
P	4.191	4.699
Q	1.219	1.372
S	3°	6°
T	3°	6°
U	3°	6°
V	2.388	2.794
W	0.356	0.635
W1	0.356	0.520
X	3°	5.5°
Y	9.779	10.414
Z	3.302	3.810

Recommended Solder Pad Layout

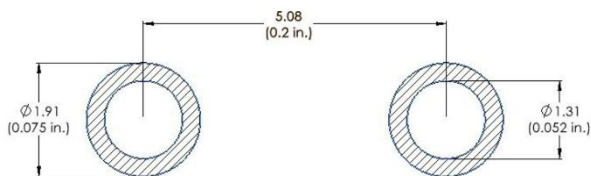

TO-220-2L

Part Number	Package
S1S65006RC1	TO220-2L



Statement:

SAN-U owns the authority for final explanation of all information contained in this document, which is subject to change without notice. All the information was obtained in particular environments; and SAN-U will not be responsible for the performance of the customers' actual operating environments. All information contained is only for the users' reference and shall not be considered as warranted characteristics. SAN-U will not be liable for damages arising directly or indirectly which from any use of the information contained in this document.

Contact Information:

Address: N501-505 Weiye Bldg., Xiamen Pioneering Park For Overseas Chinese Scholars, Xiamen, Fujian, China

Tel: +86-592-3898601, 3898608, 5318000

Fax: +86-592-5703588

Email: sales@san-u.com

<http://www.san-u.com>